



Monteringsanvisning



Assembly Instructions



Monteringsanvisning

Produkt nr. / Product no. / Produkt nr.

16-300-030

Ordr. nr. _____

Dato. _____

Sign. _____

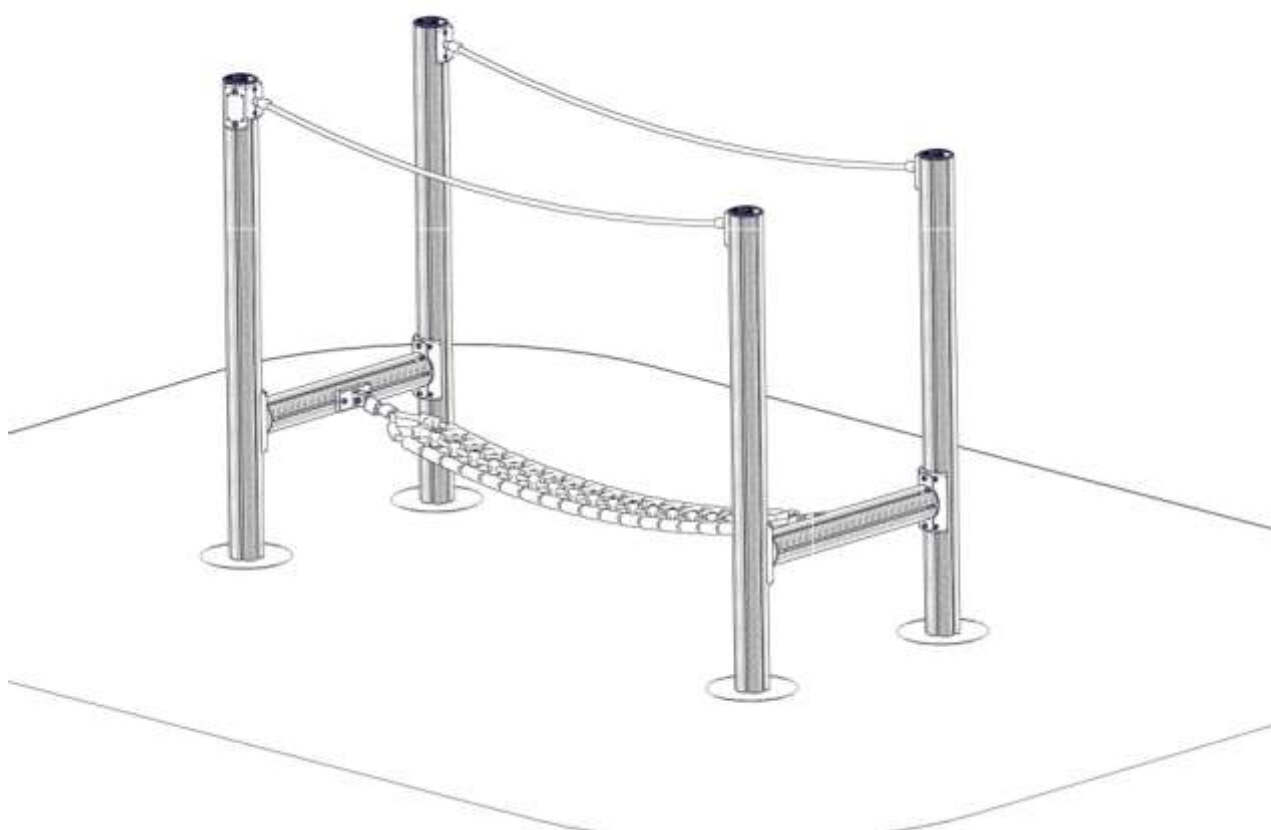

Søve Lekemiljø AS
3830 Ulefoss - Norway
Tlf: +47 35 94 65 65
www.sove.no



Søve AB
EA Rosengrensgatan 32
421 31 Västra Frölunda
Phone: +46 (0)31 773 97 00
www.sove.se

Monteringstips / Assembly Advice / Monteringsstips

N

- Les monteringsanvisningen nøye før montering.
- Monter elementene i rekkefølgen som vist.
- Boltene bør ikke skrues for hardt til før alt er montert, vatret og loddet. Skru så boltene til.
- NB! Ved bruk av drill, kan boltene ryke.
- På grunn av at solen kan gjøre rutsjeplaten veldig varm, bør rutsjebanens utløp vende mot nord-øst eller nord-vest.
- Er lekeutstyret plassert i naturlige ferdselstraséer må området sikres mot gjennomgang.
- Innspringningshinder bør vurderes rundt lekeapparater hvor det er stor bevegelse, f.eks. ved huskestativ.
- Det bør være fritt innsyn til lekeutstyr som er beregnet for barn under 3 år.

NB! Under monteringsarbeidet må utstyr, som ikke er forankret forsvarlig i bakken, sikres slik at det ikke velte.

Området må avstenges under montering av apparatene med sperrebånd eller lignende.

UK

- Read the instruction carefully before assembling the play unit..
- Assemble the components in the sequence shown in these instructions.
- Fixings must not be fully tightened during assembly. Before casting the foundations, the structure must be level and plumb, at which point all fixings are tightened.
- PS! If use of drill, the bolts may be wrecked.
- Avoid positioning the slide facing due south because of overheating – ideal positions are facing north-east or north-west.
- Secure the construction-area to prevent people from walking through it.
- Consider installing barriers around play-equipment which gives rise to a lot of activity – i.e.swings.
- Ensure that clear vision is possible across the play area so that supervision is possible from any position, particularly where children under 3 years of age will be playing.

NB! During assembly of the equipment, ensure that all structures are securely propped, especially when left overnight. Also ensure that equipment is supported whilst concrete foundations are setting and enclose the area securely to prevent access.

Monteringstips / Assembly Advice / Monteringsstips

S

- Läs monteringsanvisningen noga före montering.
- Montera delarna i den ordningen som anvisas
- Skruvarna bör inte skruvas för hårt tills allt är monterat, i våg och lodat.









OBS! Används elektrisk skruvdragare, kan bulten gå sönder. Hårdra därför manuellt!

- Solen kan göra att rutchbanan blir väldigt varm. Banans nedfart rekommenderas att vändas i norrlig riktning
- Om lekplatsen placeras vid en gångväg mm bör området säkras mot genomfart av gående och cyklister.
- Insprängningshinder bör placeras runt lekutrustning med stor rörelse, t ex, gungställning.
- Det bör vara fri insyn till lekutrustning beräknat till barn under 3 år.

OBS! Under monteringsarbete bör utrustningen som inte ska förankras i marken, ställs så att den inte kan välta.

Området måste spärras när lekutrustningen byggs upp, med avspärrningsband eller liknande.

Nødvendig verktøy / Tools required / Nödvändiga verktyg

<p>(N)</p> <p>(UK)</p> <p>(S)</p>	<p>(A)</p> 	<p>(B)</p>  <p>Torx Nr 45 High quality</p>	<p>(C)</p>	<p>(D)</p> 	<p>(E)</p> 
		<p>Metermål</p> <p>Metric measure</p> <p>Tumstoc</p> 	<p>16 V</p> 	<p>Merkebånd</p> <p>Mark ribbon</p> <p>Märkeband</p> 	

Nødvendig antall personer / Number of persons required / Lämpligt antal personer





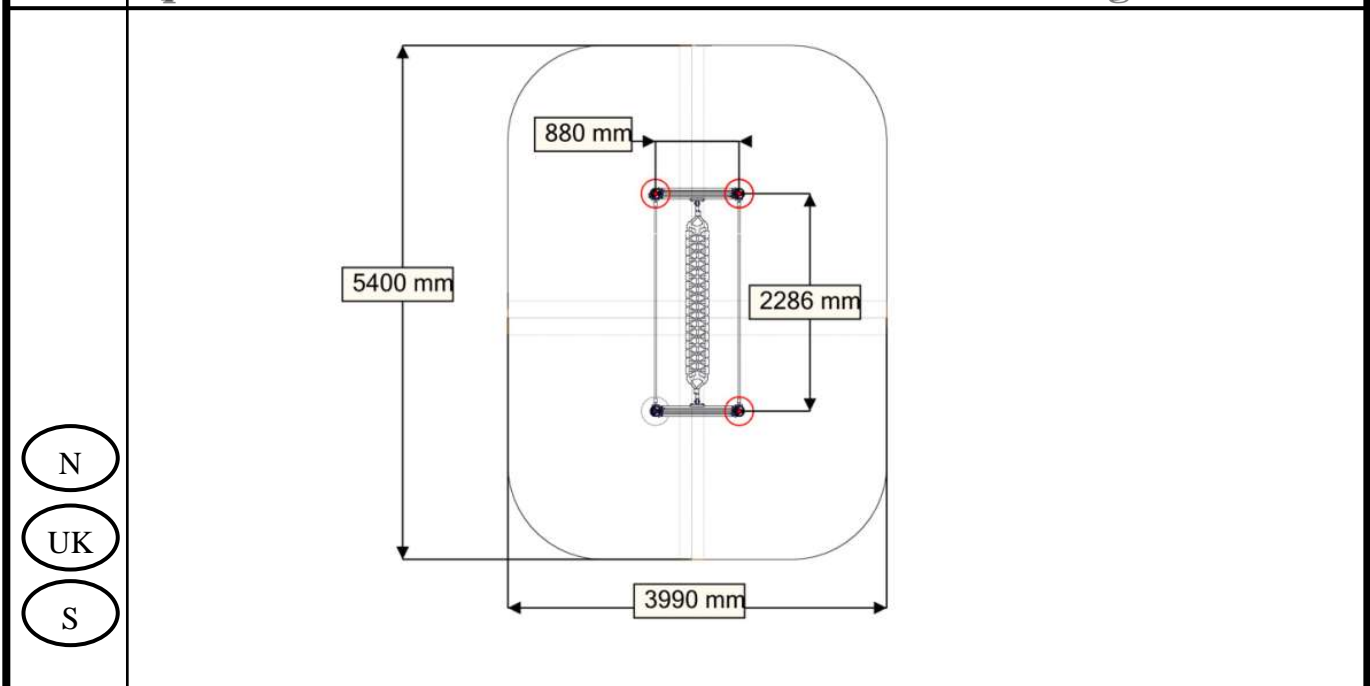



<p>(N)</p> <p>(UK)</p> <p>(S)</p>	
-----------------------------------	---

Anbefalt arealbehov ved montering / Recommended working space / Rekommenderad arealbehov vid montering

















Boltepakker for / Boltpackage for / Bultpaket för

Sign. _____.

Stolpe 110	Ant= 4	Navn	Artnr/dimensjon	Ant	Lev
		Stolpe 110 L=2200 600-1600 (1)	07-100-322	4	
Stolpe 110 drager med beslag og SmalTimble	Ant= 2	Navn	Artnr/dimensjon	Ant	Lev
		Stolpe 110 L=738 (1) Med beslag tau og endebeslag	07-150-307	2	
		Beslag 30gr_200_4H 2T(2)	07-150-042	4	
		Brikke 200_2T (4)	04-060-200	8	
		Torx M8x25(12)	04-000-025	24	
Stolpende	Ant= 4	Navn	Artnr/dimensjon	Ant	Lev
		End lokk (1)	00-400-995	4	
Fundamnet støpes	Ant= 4	Navn	Artnr/dimensjon	Ant	Lev
		End lokk m/ hull (1)	00-400-996	4	
		Sekskant M8x70(3)	04-008-070	12	
		Brikke 50 (3)	04-060-050	12	

Boltepakker for / Boltpackage for / Bultpaket för

Sign. _____.

Produktmerke	Ant= 1	Navn	Artnr/dimensjon	Ant	Lev
		Ogr 150_2H (2) Med Produktmerke	???	1	
		Brikke 150_2T(2)	04-060-151	1	
		Torx M8x35 (2)	04-000-035	2	
GåNett	Ant= 1	Navn	Artnr/dimensjon	Ant	Lev
		Gå Nett (1)	07-500-345	1	
		Sekskant M10x45(2)	04-010-045	2	
		Låse mutter M10 (2)	04-040-010	2	
		Skive M10 (4)	04-050-010	4	
GåNett gelendetau	Ant= 2	Navn	Artnr/dimensjon	Ant	Lev
		Gå tau (1)	07-500-349	2	
		Beslag Ogr_120_2H_1V(2) Montert på tau	07-150-024	0	
		Brikke 120_3T(2)	04-060-120	4	
		Torx M8x25(4)	04-000-025	8	

Fundamentering med betong / Foundation concrete / Förankring med betong

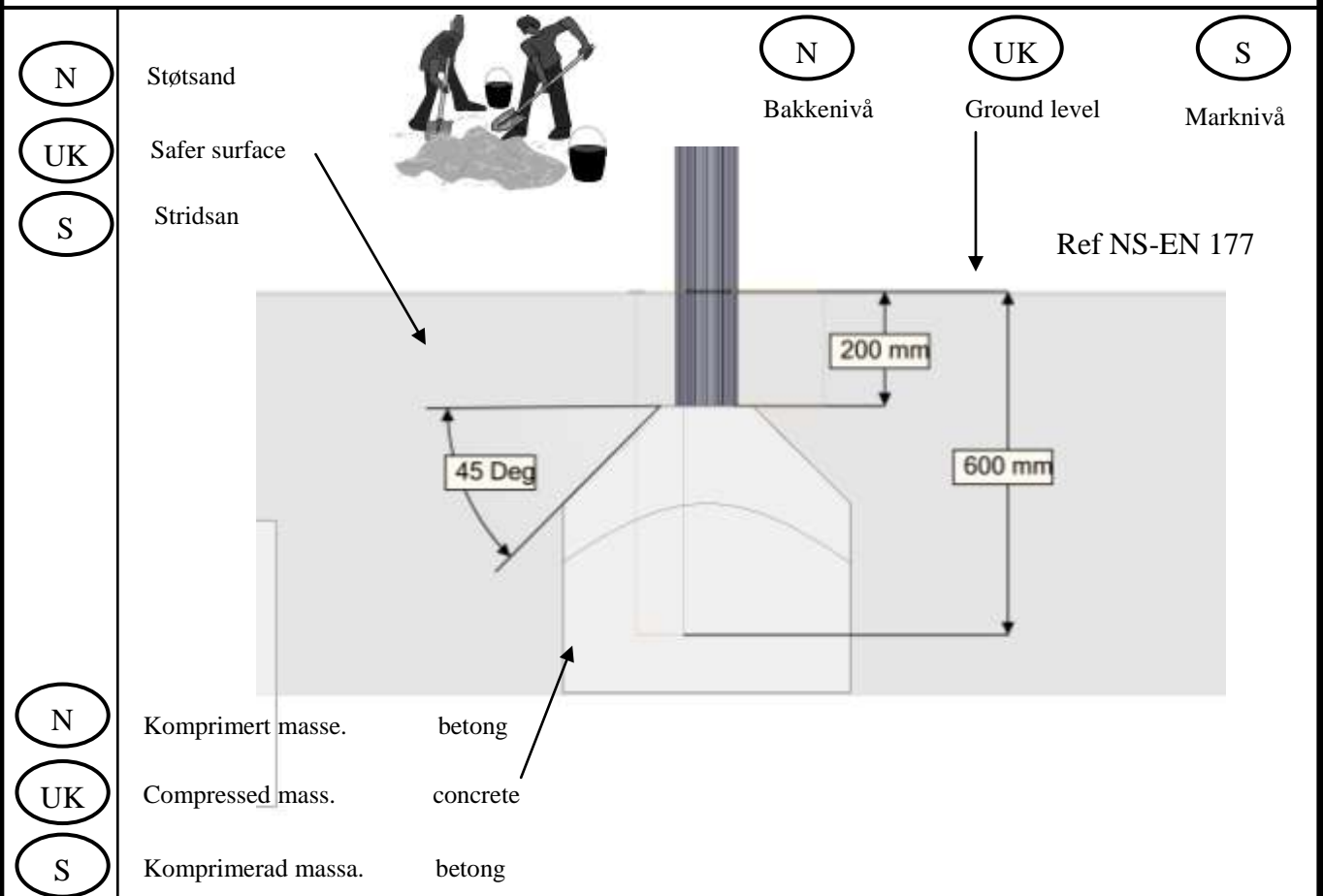

Fundamentering uten betong / Foundation without concrete / Förankring utan betong

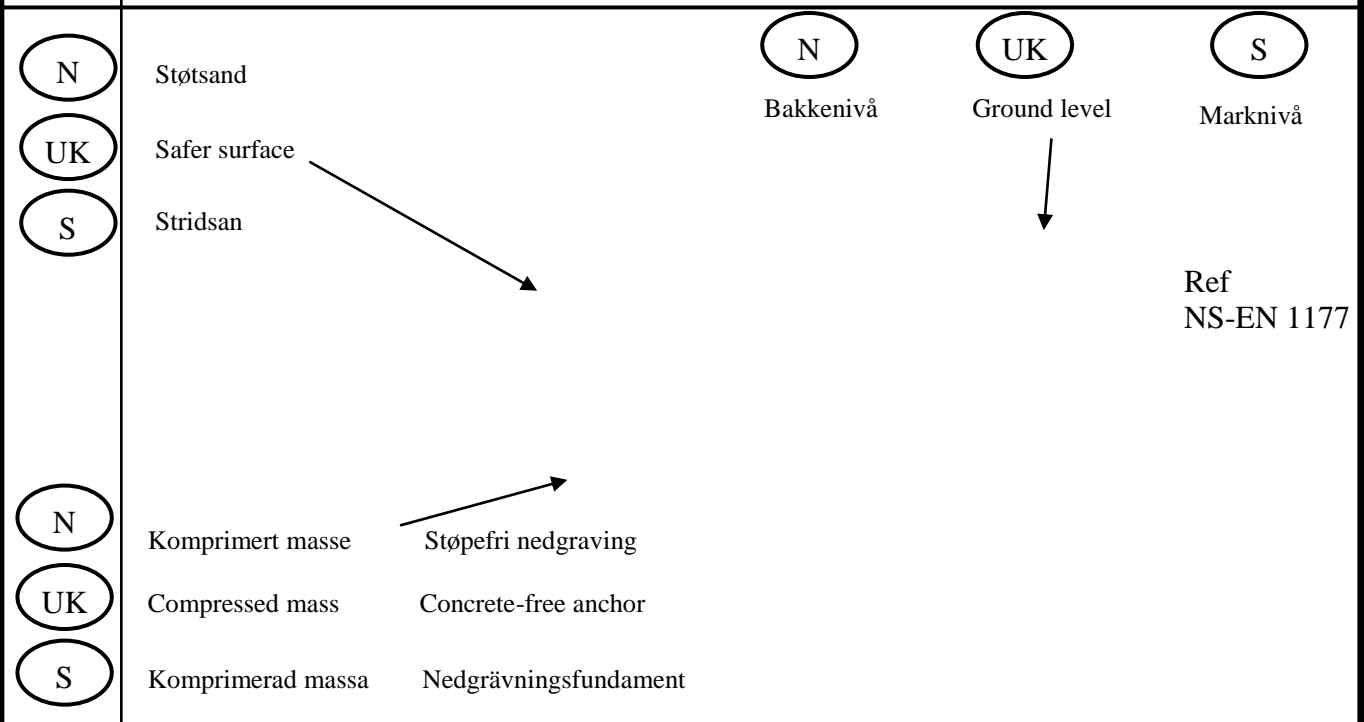

(N)	Alle mål er oppgitt i millimeter
(UK)	Scale measured in mm
(S)	Alla mått är i millimeter.

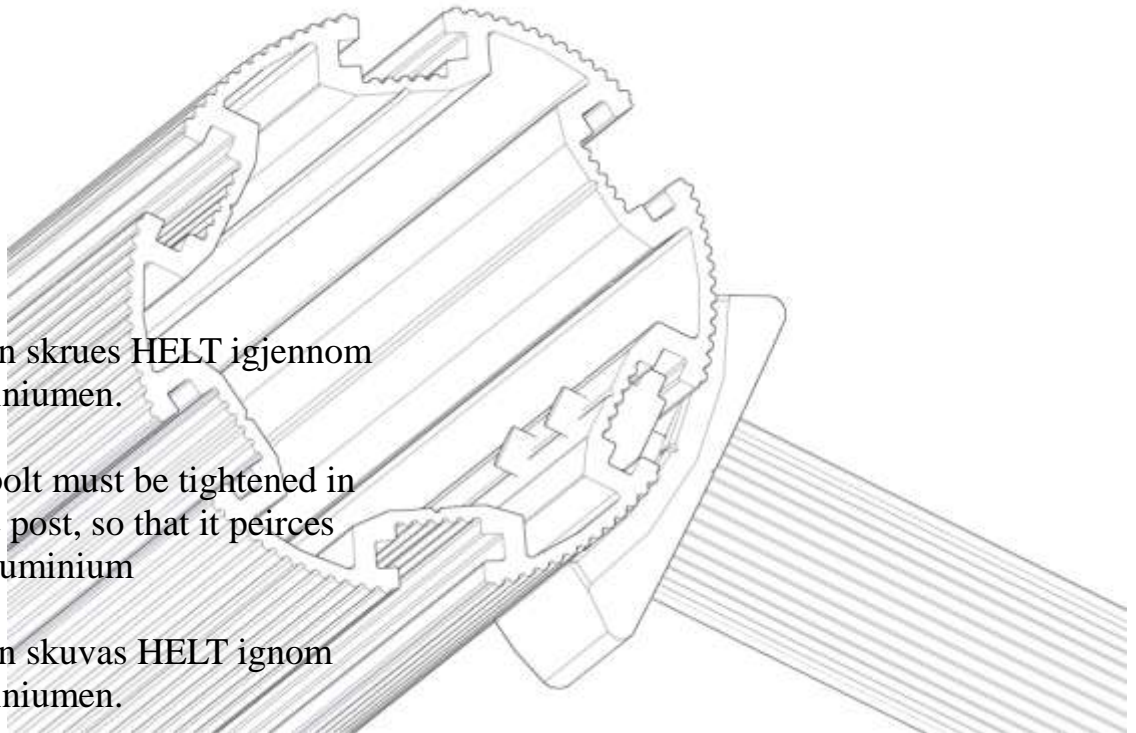

N

Bolten skrues HELT igjennom aluminiumen.

UK

The bolt must be tightened in to the post, so that it peirces the aluminium

S

Bulten skruvas HELT ignom aluminiumen.

Fallhøyder / Free height of fall / Fallhöjder

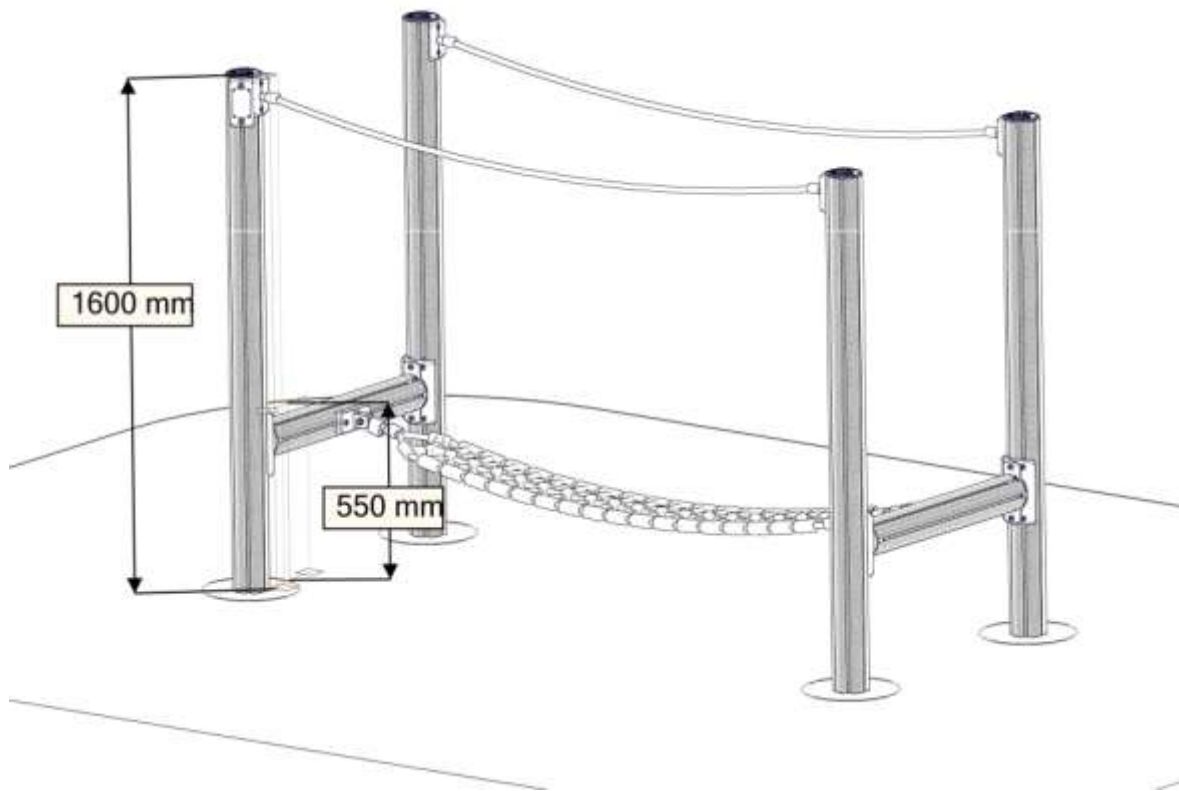

Sikkerhetszone / Safety zone / Säkerhetszon

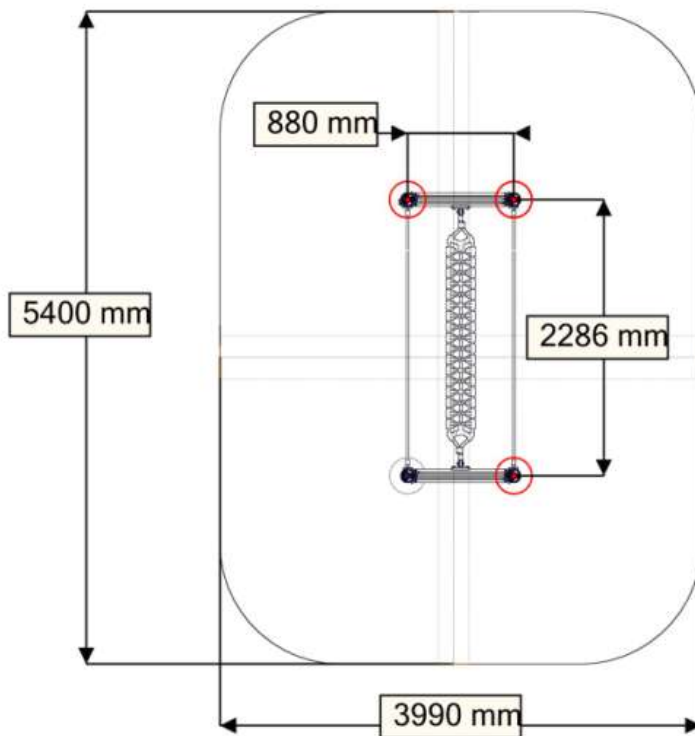

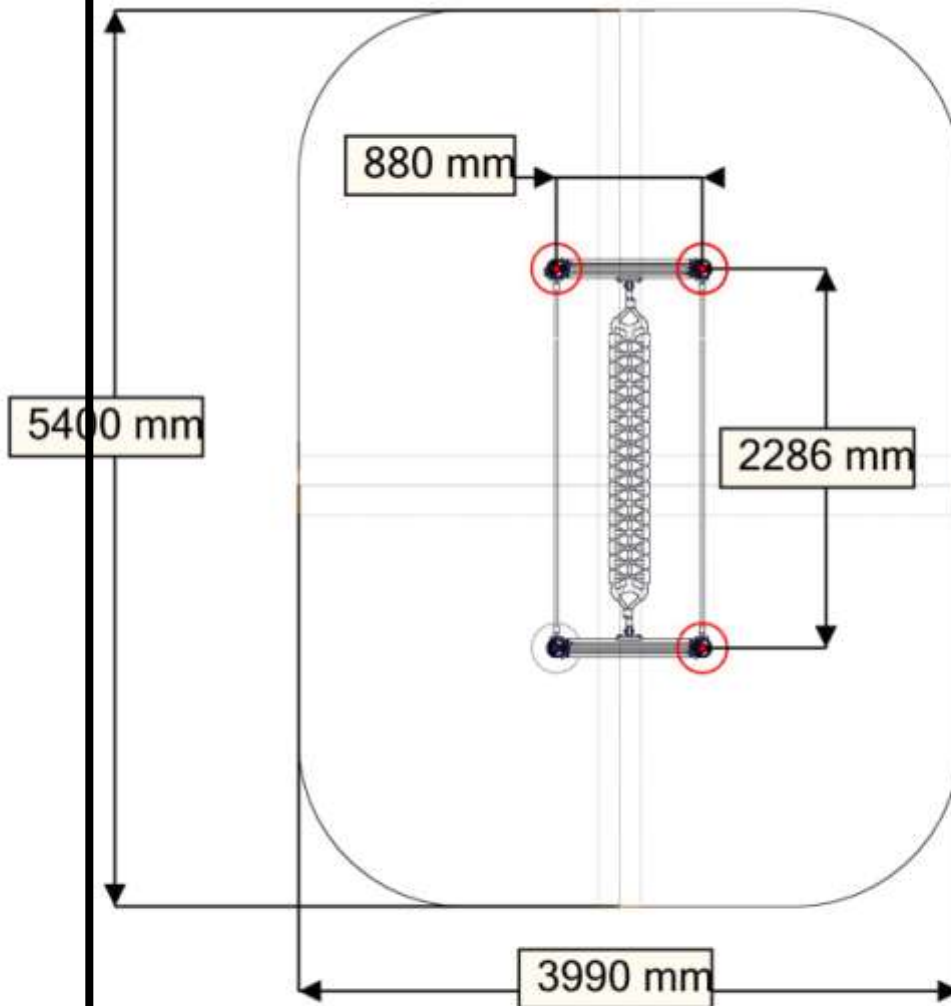
Plassering av forankringer / Ground plan / Placering av förankringar

N

Alle mål er oppgitt i millimeter

UK

Scale measured in mm

S

Alla mått är i millimeter.

Montering av lekeapparatet / Assembly instructions / Montering av lekredskapet

2x

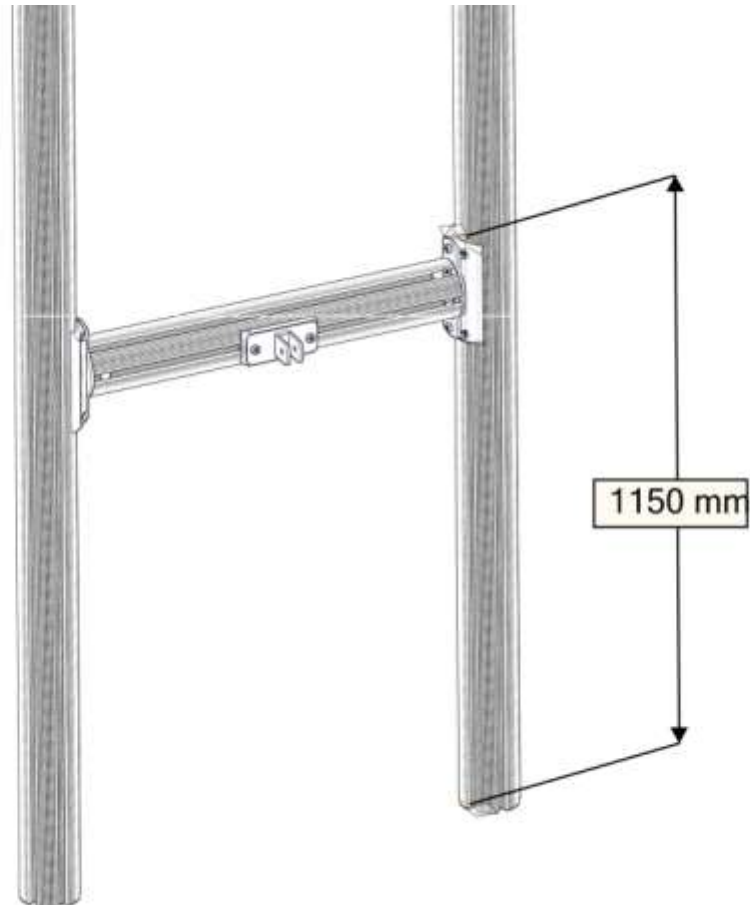

2x

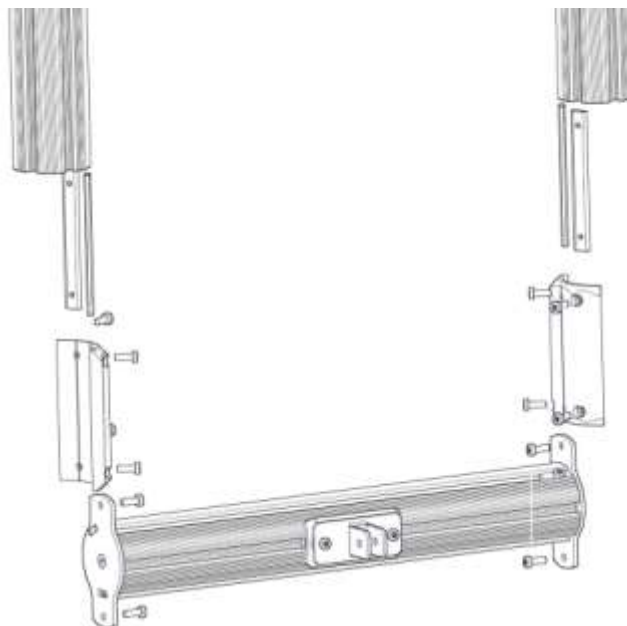

BOM ID	Name	SW Configuration	Artnr (config)	Qty
1	30gr_74567-B-1	30gr_200_4H2T	07-150-042	2
2	6SP110_74569-0Tower3-1	680	07-150-307	1
3	brikke_SFA5116-	200_2T	04-060-200	2
4	TorxM8-	TXM8x25	04-000-025	12

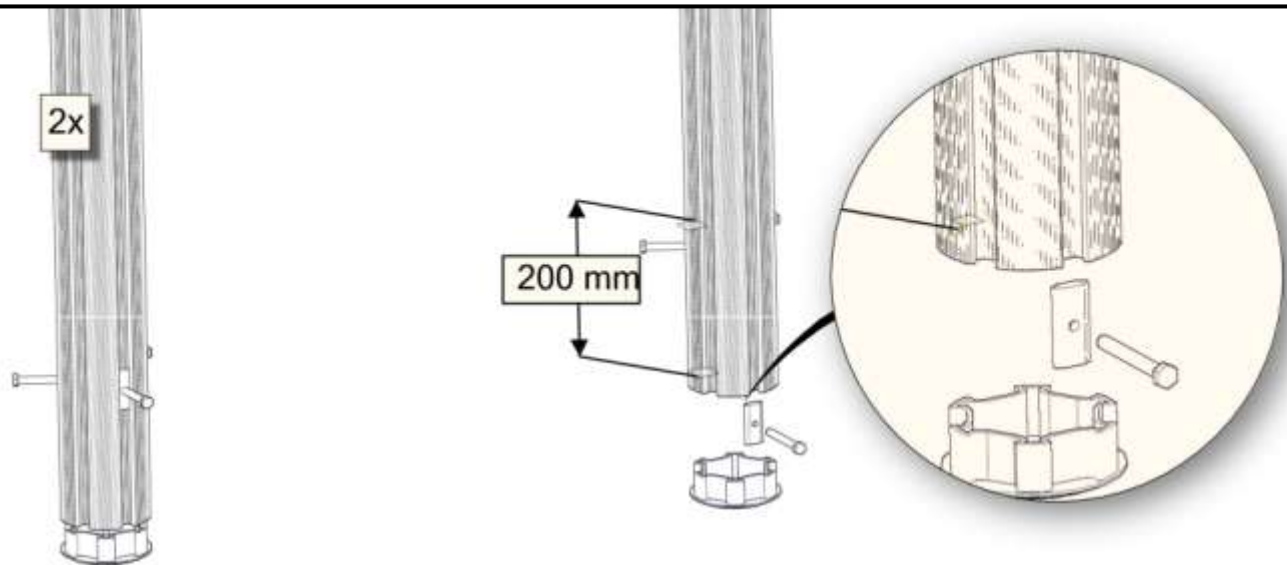

BOM ID	Name	SW Configuration	Artnr (config)	Qty
1	brikke_SFA5116-1	50_1T	04-060-050	6
2	M8_sekskant-1	M08x70	04-008-070	6
3	StolpEndeSove_V2-2	med hull	00-400-996	2



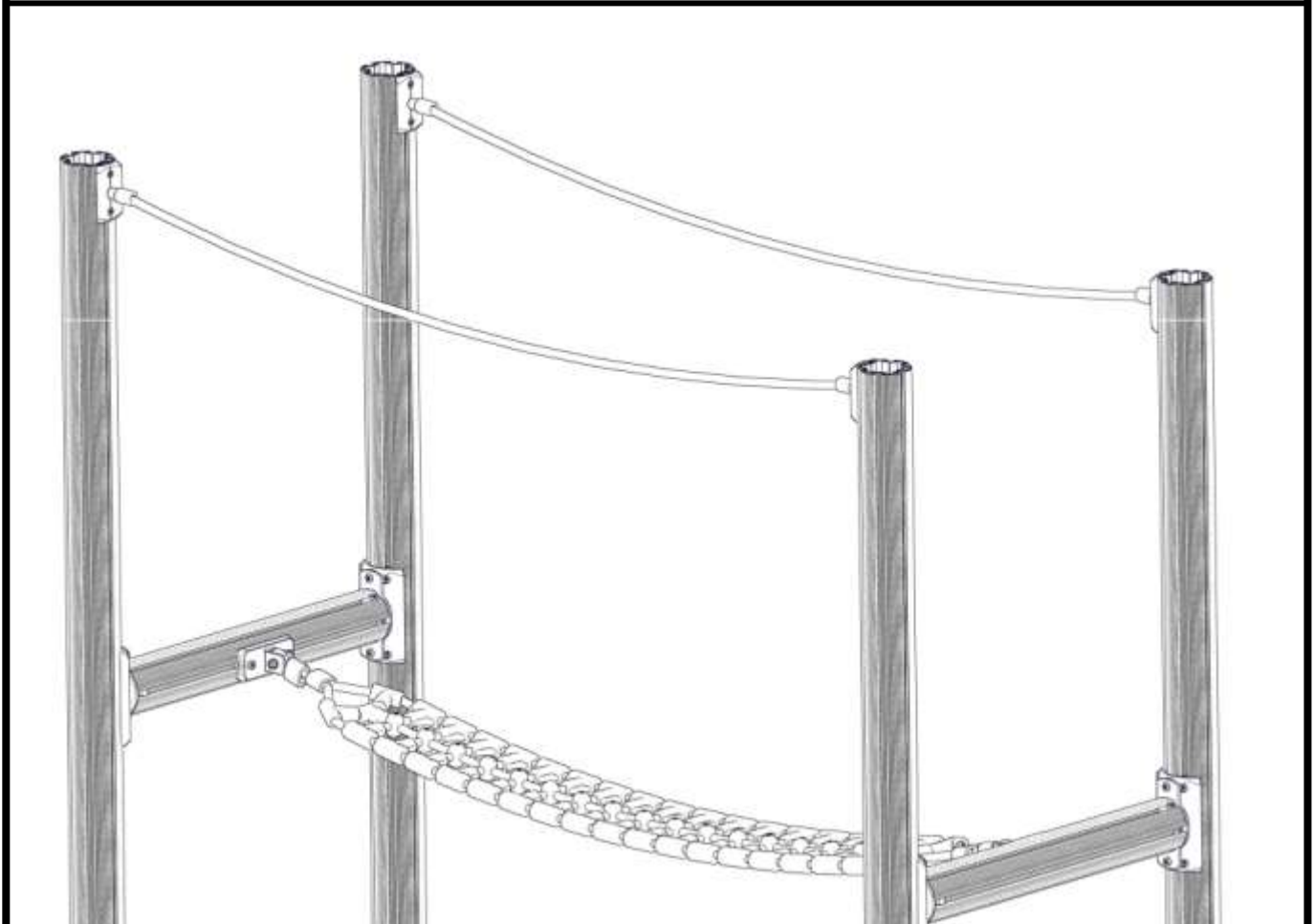
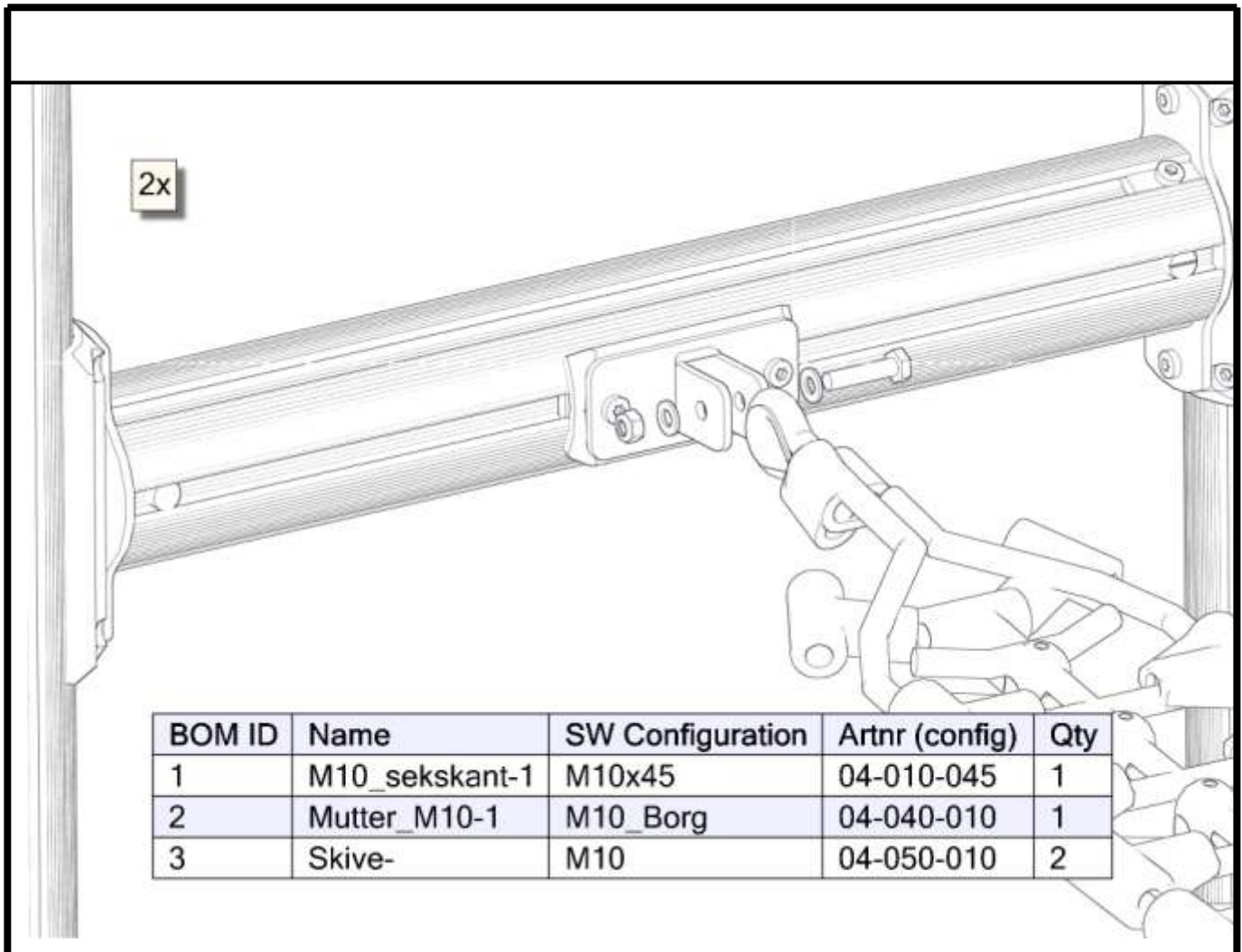

4x

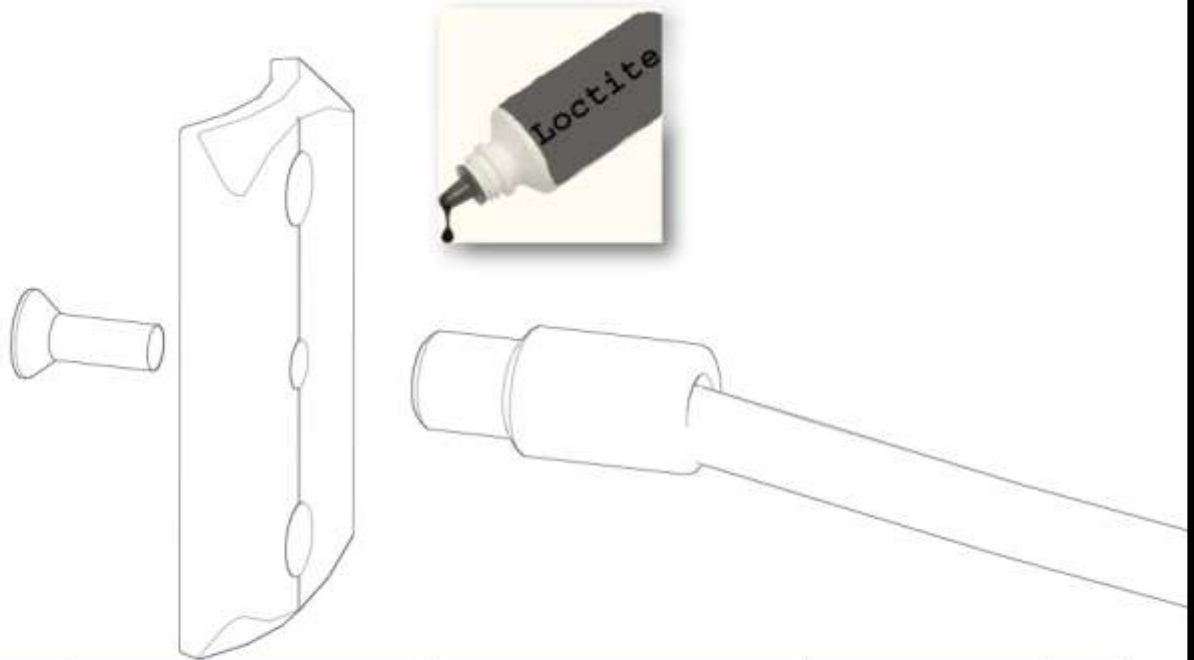

BOM ID	Name	SW Configuration	Artnr (config)	Qty
3	0gr_74568-B-1	0gr_120_2H_1V10	07-150-024	1
4	M10_V_Umbrako-1	M10x25	04-037-025	1
5	TauBalansbruHand-1	Default<As Machined>	07-500-080	1

4x

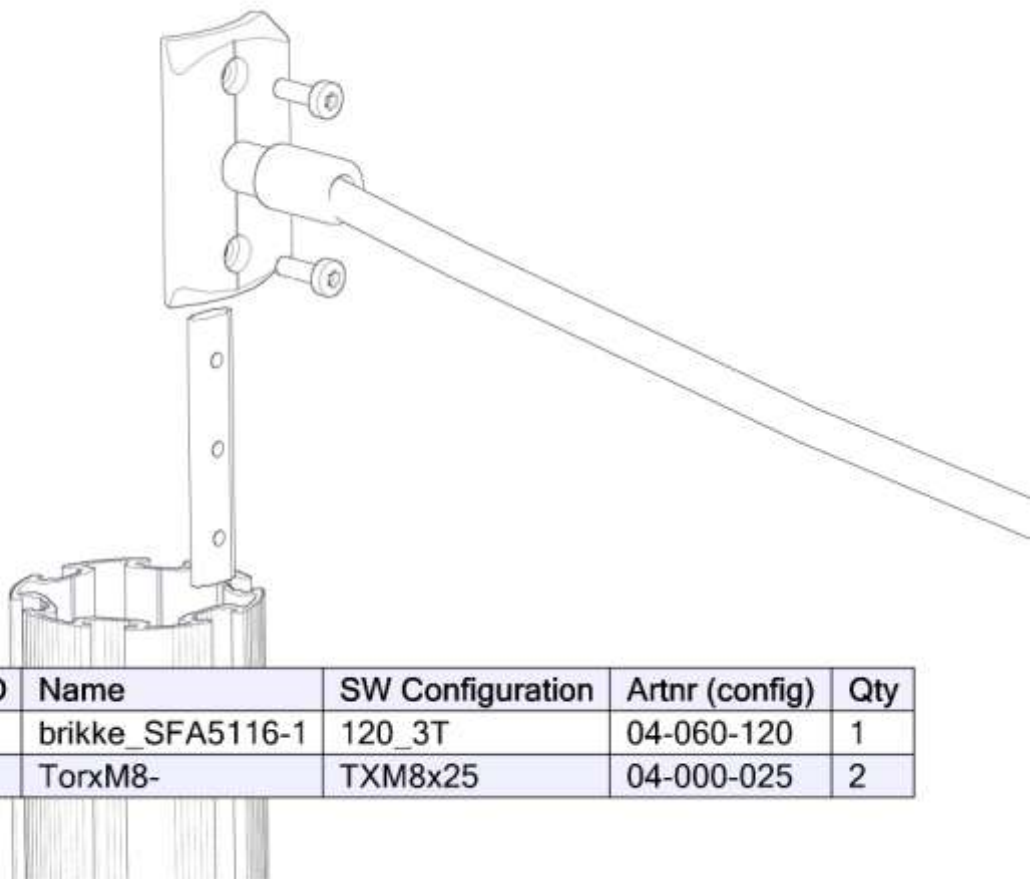

BOM ID	Name	SW Configuration	Artnr (config)	Qty
1	brikke_SFA5116-1	120_3T	04-060-120	1
2	TorxM8-	TXM8x25	04-000-025	2

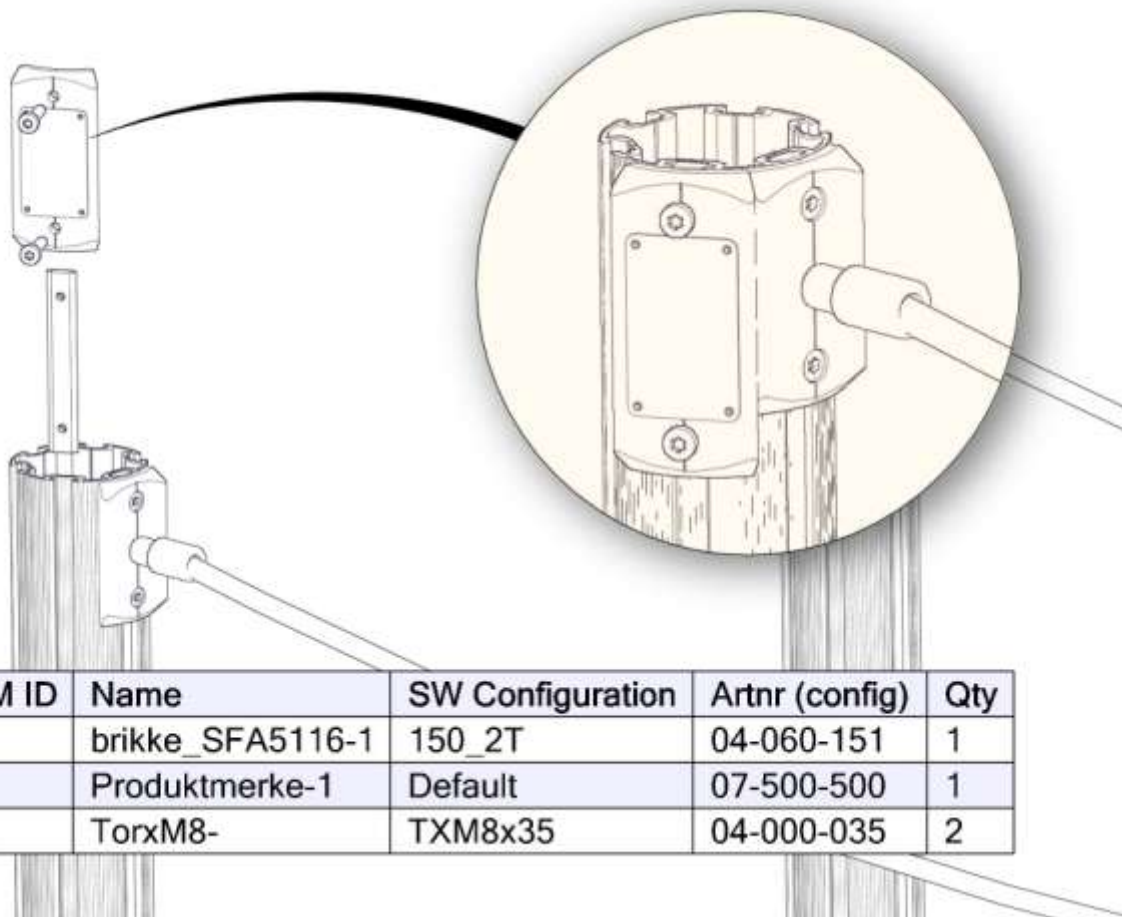

BOM ID	Name	SW Configuration	Artnr (config)	Qty
1	brikke_SFA5116-1	150_2T	04-060-151	1
2	Produktmerke-1	Default	07-500-500	1
3	TorxM8-	TXM8x35	04-000-035	2

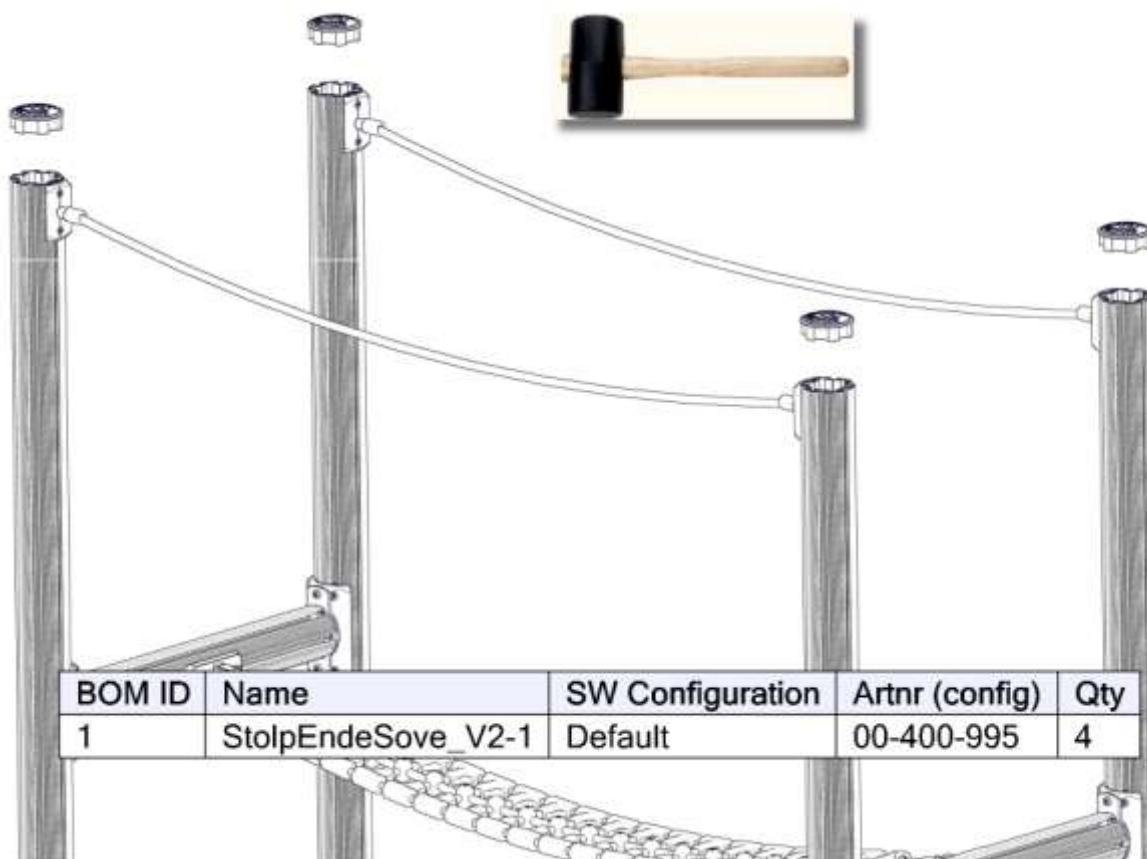



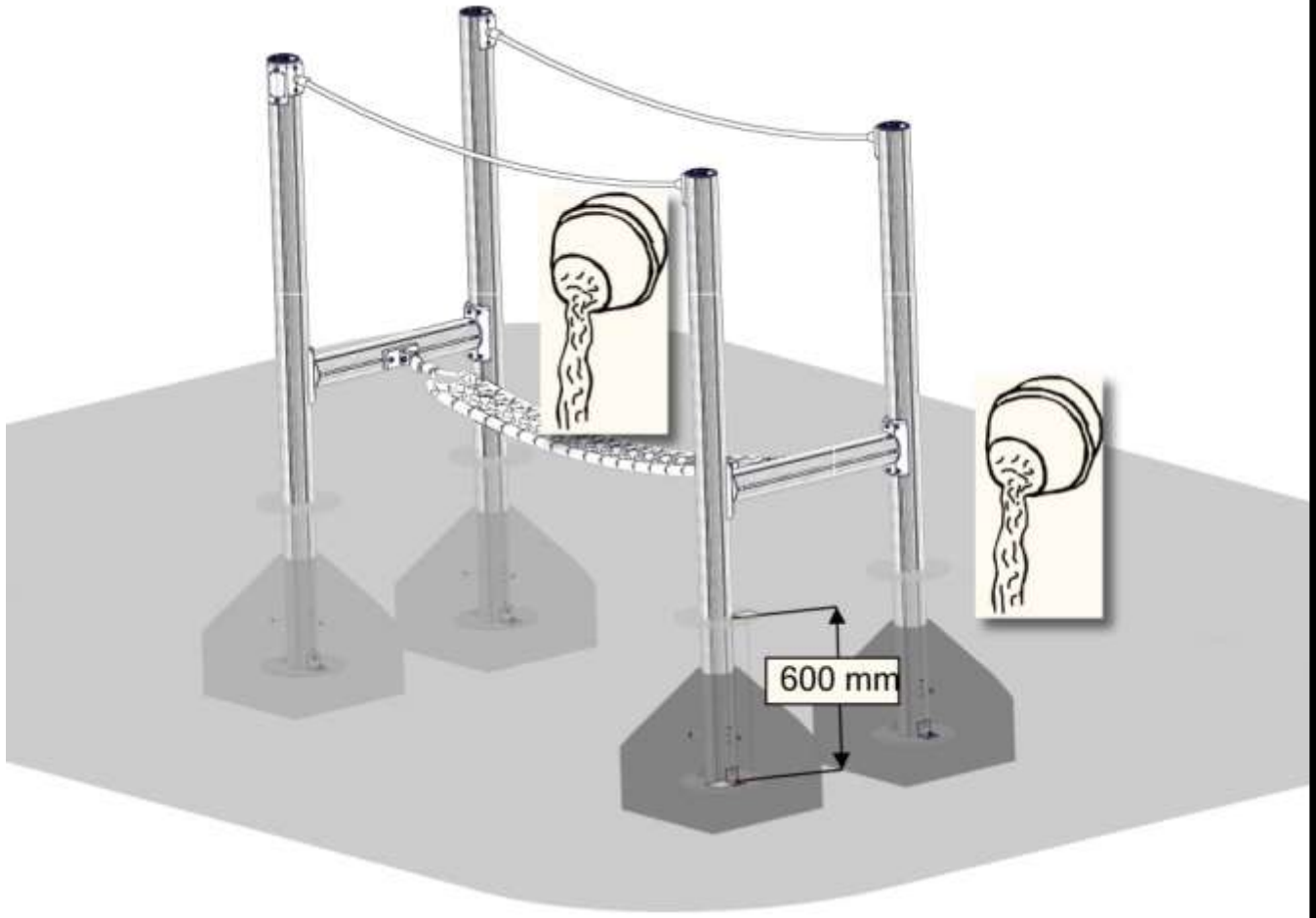





BOM ID	Name	SW Configuration	Artnr (config)	Qty
1	StolpEndeSove_V2-1	Default	00-400-995	4



Før utstyret tas i bruk / Before play begins / Innan lekredskapet tas i bruk	
N	<ul style="list-style-type: none"> ● Påse at fallunderlag er utlagt i henhold til gjeldende regler eller vår anbefaling ● Fjern alle monteringshjelpemidler (rester av betong, planker, paller, plast, og lignende) ● Før utstyret tas i bruk, burde man sjekke at det ikke er fare for at anorakksnorer og lignende som kan hekte seg fast noen steder på lekeapparatet. (Vedlagte snor med dobbe (kneledd) kan brukes til å sjekke at dette er i orden. Se vedlagte veiledning for bruk av denne. Dette gjøres for å oppdage eventuelle feilmonteringer.) ● NB! Bør stå i 2-3 dager før bruk
UK	<ul style="list-style-type: none"> ● Make sure the area and depth of safer surfacing are according to the current standard, or to the manufacturer's recommendation ● Make sure all tools and surplus materials are removed before play begins ● PS! When complete, allow 2-3 days for the concrete to set before use
S	<ul style="list-style-type: none"> ● Kontrollera att fallunderlag är utlagt enligt gällande regler eller vårt rekommendation ● Ta bort alla monteringshjälpmedel (rester av betong, plankor, pallar, plast och liknande) ● Innan lekredskapet används, kontrollera att anoracksnoddar eller kläder/delar av kläder eller liknande inte kan fastna i några delar på redskapet. (Den bipackade "knävringen" kan man med fördel användas för denna kontroll. ● Detta görs för att upptäcka eventuella felmonteringar.)















Boltepakker for / Boltpackage for / Bultpaket för

Sign. _____

Stolpe 110	Ant= 4	Navn	Artnr/dimensjon	Ant	Lev
		Stolpe 110 L=2200 600-1600 (1)	07-100-322	4	
Stolpe 110 drager med beslag og SmalTimble	Ant= 2	Navn	Artnr/dimensjon	Ant	Lev
		Stolpe 110 L=738 (1)	07-150-307	2	
		Beslag 30gr_200_4H 2T(2)	07-150-042	4	
		Brikke 200_2T (4)	04-060-200	8	
		Torx M8x25(12) T	04-000-025	24	
Stolpende	Ant= 4	Navn	Artnr/dimensjon	Ant	Lev
		End lokk (1)	00-400-995	4	
Fundamnet støpes	Ant= 4	Navn	Artnr/dimensjon	Ant	Lev
		End lokk m/ hull (1)	00-400-996	4	
		Sekskant M8x70(3)	04-008-070	12	
		Brikke 50 (3)	04-060-050	12	

Boltepakker for / Boltpackage for / Bultpaket för

Sign. _____.

Produktmerke	Ant= 1	Navn	Artnr/dimensjon	Ant	Lev
		Ogr 150_2H (2) Med Produktmerke	???	1	
		Brikke 150_2T(2)	04-060-151	1	
		Torx M8x35 (2)	04-000-035	2	
GåNett	Ant= 1	Navn	Artnr/dimensjon	Ant	Lev
		Gå Nett (1)	07-500-345	1	
		Sekskant M10x45(2)	04-010-045	2	
		Låse mutter M10 (2)	04-040-010	2	
		Skive M10 (4)	04-050-010	4	
GåNett gelendetau	Ant= 2	Navn	Artnr/dimensjon	Ant	Lev
		Gå tau (1)	07-500-349	2	
		Beslag Ogr_120_2H_1V(2)	07-150-024	0	
		Brikke 120_3T(2)	04-060-120	4	
		Torx M8x25(4)	04-000-025	8	